

**WATER FALL bocca di erogazione a getto montaggio a muro - Light Gold
spazzolato**







IMO

13 420 979



- sporgenza 120 mm
- CASCADE, portata max. 26,5 l/min (a 3 bar)
- piastra di copertura 240 x 60 mm
- ingresso 1/2"
- montaggio con attacco rapido

Compatibile con: IMO, LULU, MADISON,
MEM, TARA, CL.1, LISSÉ, VAIA, META,
CYO

	Light Gold spazzolato	13 420 979-27
	Cromato	13 420 979-00
	Platinato spazzolato	13 420 979-06
	Platinato	13 420 979-08
	Dark Chrome	13 420 979-19
	Light Gold	13 420 979-26
	Ottone spazzolato (Oro 23k)	13 420 979-28
	Nero opaco	13 420 979-33
	Bronzo spazzolato	13 420 979-42
	Champagne spazzolato (Oro 22k)	13 420 979-46
	Champagne (Oro 22k)	13 420 979-47
	Cromo spazzolato	13 420 979-93

Prodotti complementari



- raccordo angolare ad incasso - 35 085 970 90**
- profondità d'incasso min. 90 mm
 - Profondità d'incasso max. 163 mm

Prodotti complementari



- raccordo angolare ad incasso - 35 085 970 90**
- profondità d'incasso min. 90 mm
 - Profondità d'incasso max. 163 mm

13 420 979
mm [inches]



Diagramma di portata



Diagramma gittate

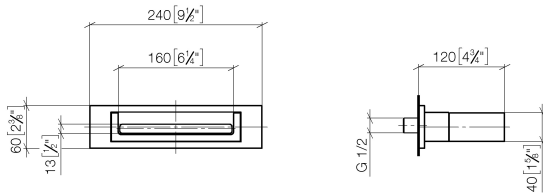

Certificati

LGA_18615.

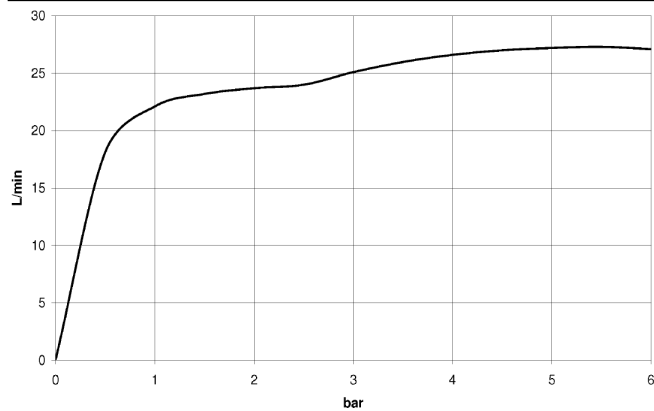
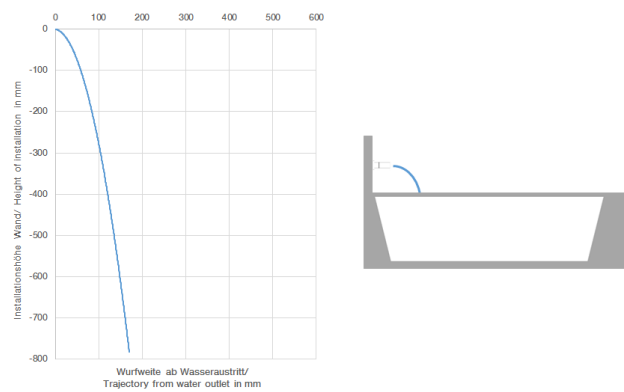
13 420 979

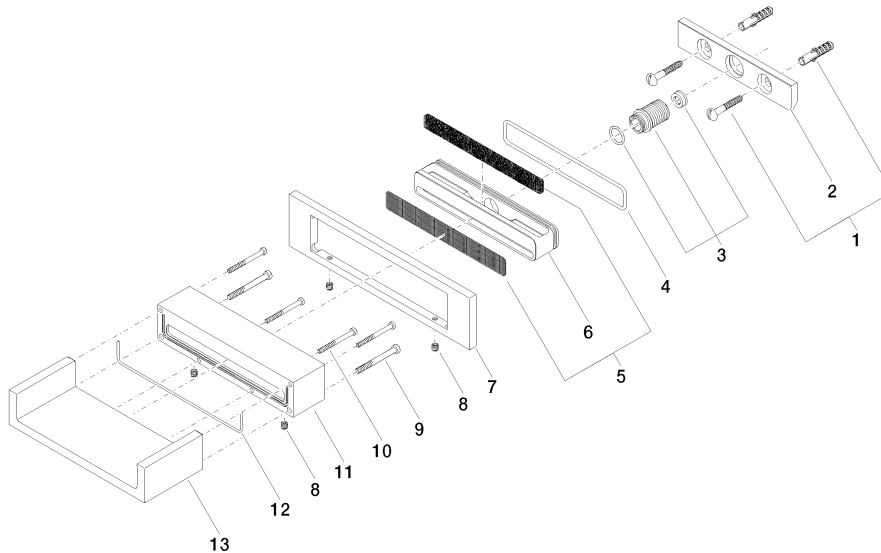

Elenco delle parti di ricambio

N.	Codice articolo	Denominazione	Quantità necessaria	Tempo di produzione
1	04 30 31 024 01 90	set di fissaggio	1	2
2	09 17 97 056 90	sostegno	1	2
3	90 24 05 008 00 90	set di nippel	1	2
4	09 14 10 504 90	guarnizione	1	2
5	90 29 30 040 00 90	inserto	1	2
6	09 17 11 044 20 90	distributore	1	2
7	09 27 97 034-27	rosetta	1	60
8	09 31 11 049 90	perno	4	2
9	09 30 30 147 90	vite	2	2
10	09 30 30 086 90	vite	4	2
11	09 30 01 104-27	scatola	1	60
12	09 14 03 504 90	guarnizione	1	2
13	09 11 94 046-27	bocca di erogazione	1	60